

**ALUMERO**

**AS 2.1**

# **TRAPEZOIDAL BRIDGE**

**EN**

**SOLAR INSTALLATION INSTRUCTIONS**

**Before installation, please read the safety instructions at the end of this installation manual very carefully – and make sure you are using the latest edition of these instructions.**

Layout and planning of this installation system should be conducted using the ALUMERO **Solar.Pro.Tool** software. Please ensure you have all the requisite materials, positioning and layouts for each individual component according to the project report provided with Solar.Pro.Tool, and/or by your ALUMERO sales partner. The data have all been calculated within statutory static tolerance levels and are of great importance to the safe and smooth operation of the system.

Prior to commencement, technicians responsible for installing the photovoltaic system must ensure the existing roof construction is capable of bearing the additional loads and forces.

These installation instructions explain correct mounting procedures for ALUMERO trapezoidal bridge components, how to attach them to the roof substructure and how to mount the modules.

Generally, substructures are made of purlins. For 'Trapezoidal Bridges' installed on trapezoidal sheet roofs it is essential that these purlins are connected directly to the trapezoidal sheets. As a rule, the modules are mounted vertically so that the mounting truss profiles run parallel to the ridge of the roof.

The ALUMERO 'Trapezoidal Bridge' system is intended solely to carry PV modules. Any other applications of the system shall be considered examples of misuse.

**We do not recommend installing extra-tilt frames.**

Mounting must only be conducted by trained personnel. Roofing tasks in particular should only be carried out by professional roof contractors.

If you have any other questions, please take advantage of the comprehensive professional advisory service provided by ALUMERO's expert construction engineers.

## LIST OF CONTENTS

General information.....	P 3
Components.....	P 4-5
How to install trapezoidal bridges / modules vertically.....	P 6-7
Thermic separation and maintenance gaps.....	P 8
How to mount modules.....	P 9
How to install trapezoidal bridges / modules horizontally.....	P 10-11
Thermic separation and maintenance gaps.....	P 12
How to mount modules.....	P 13
How to attach modules   Equipotential bonding   Earthing.....	P 14-15
Key points.....	P 16-20

## GENERAL INFORMATION

<b>Minimum sheet thickness:</b>	Steel sheet 0.4mm Aluminium sheet 0.5mm
<b>Roof gradients:</b>	Max. 45°
<b>Trapezoidal sheet profiles:</b>	Minimum sheet profile width 22 mm (25 mm recommended). The height of the profile is not relevant.
<b>Distance between sheet profiles:</b>	100-333 mm
<b>Means of attachment::</b>	Self-drilling screws for thin sheet metal
<b>Max. module field size:</b>	12 m (length)
<b>Screw mounting:</b>	M8 (A2-70)      M10 (A2-70)
<b>Torque:</b>	<b>15 Nm</b> <b>30 Nm</b>

39/333,3

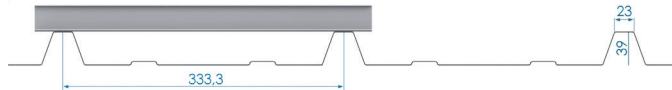

38/300

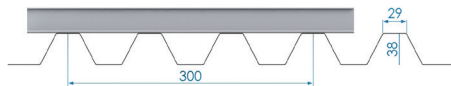

158/250

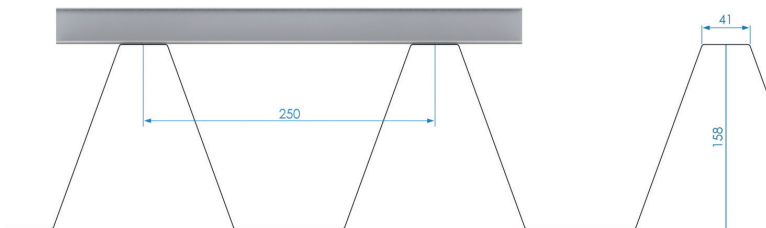

## TOOLS REQUIRED

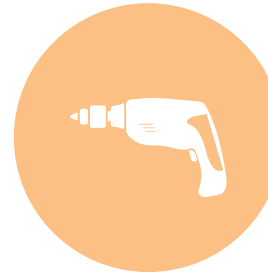

**Battery-powered drill**  
with the following bits:  
Hex bit **SW 5, SW 6**  
**SW 13 bit**

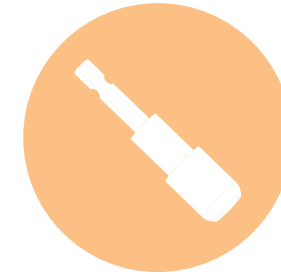

**Bit attachment SW 8**

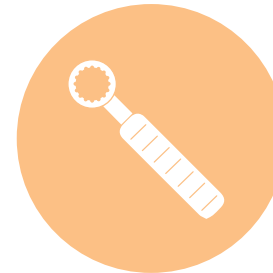

**Torque wrench**



**Measuring tape**



**Chalk line tool**

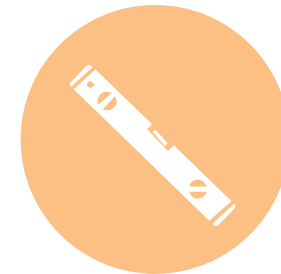

**Spirit level**

# COMPONENTS

## STANDARD



**Trapezoidal bridge 2.1**  
**L=400**  
Product number:  
802440



**Trapezoidal bridge 2.1**  
**L=250**  
Product number:  
802441



**Preassembled closing clamp with a pin**  
Product number:  
802304-xxV P1



**Preassembled closing clamp**  
Product number:  
802304-xxV



**Click end clamp with a pin**  
Product number:  
802304CP



**Click end clamp without a pin**  
Product number:  
802304C



**Click middle clamp with a pin**  
Product number:  
802301C P1 30-45



**Click middle clamp without a pin**  
Product number:  
802301C 30-45

# COMPONENTS

---

## ACCESSORIES



**Cable tie with a clip**

Product number:  
802604



**Wire clamp**

Product number:  
802603



**Aluminium wire**

Product number:  
802602

## MOUNTING WITH TRAPEZOIDAL BRIDGES VERTICAL MODULE ARRANGEMENT

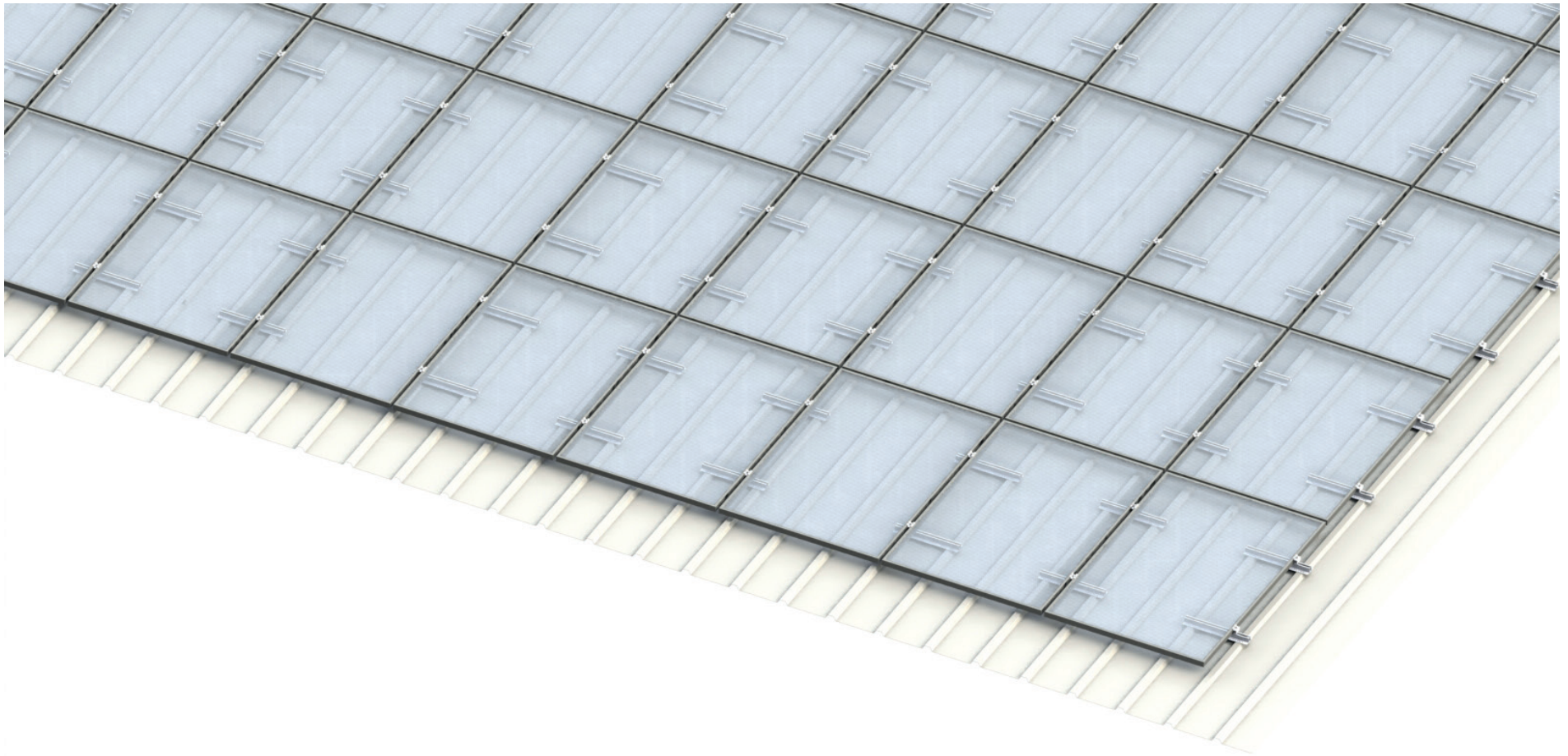

# 1

## MEASURE AND MARK POSITIONS

Measure, position and mark the locations for the trapezoidal bridges on the roof according to the Solar.Pro.Tool project report. Measure the gap between the trapezoidal sheet profiles and position the trapezoidal bridges.

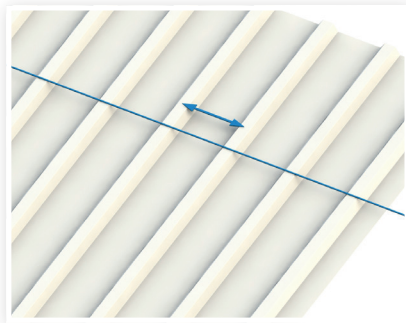

# 2

## MOUNTING TRAPEZOIDAL BRIDGES

Screw the Trapezoidal Bridge straight into the purlins with 4 self-drilling screws right in the middle of roof sheet profiles. Please note that the EPDM sealing beneath the Trapezoidal Bridge and the sealing discs of the self-drilling screws must not be compromised by more than 50%. The gap between the self-drilling screws and the edge of the roof profile must be at least 8mm.

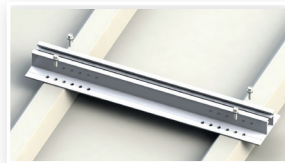

**Please note:** Once mounted, trapezoidal bridges must not be used as footholds!

When placing the subsequent trapezoidal bridges on the next roof profiles, ensure the correct **gap of X** to the truss profiles yet to be mounted can still be achieved. The **gap (X)** depends on the width of the module and clamping width (20mm) + the minimum gap to the end of each trapezoidal bridge (20mm).

**Gap Y** depends on the length of the modules and should be chosen to allow clamping in the specified clamping areas.

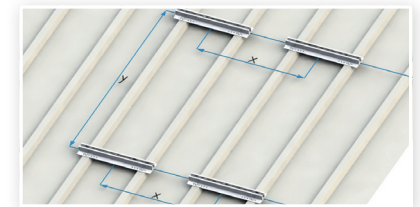
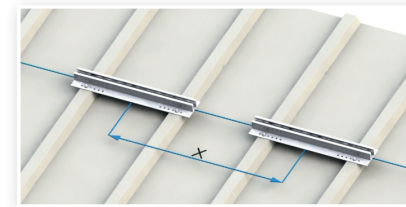

**Please note:** Adhere to the clamping areas and find out the loads and forces they cause in the installation manual for your specific module.

### Information about screws for thin sheet metal

Turn the self-drilling screws slowly, in a controlled manner and using low torque to ensure you do not over-rotate the screws or damage the sheet metal. Turn the screw until the EPDM sealing under the rail and the self-drilling screws is pressed to around 50% of its original thickness. Continuing to screw no longer strengthens the connection, but instead increases the risk of material failure.

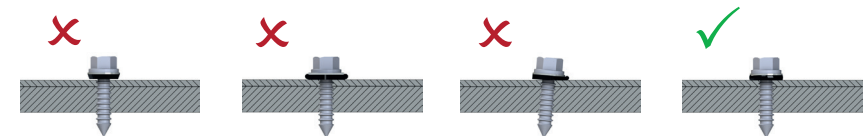

# THERMIC SEPARATION AND MAINTENANCE GAPS

Adhere to the maximum module field length of 12m. There must be a thermic gap between modules once this length is reached. We suggest leaving a gap of one sheet metal profile.

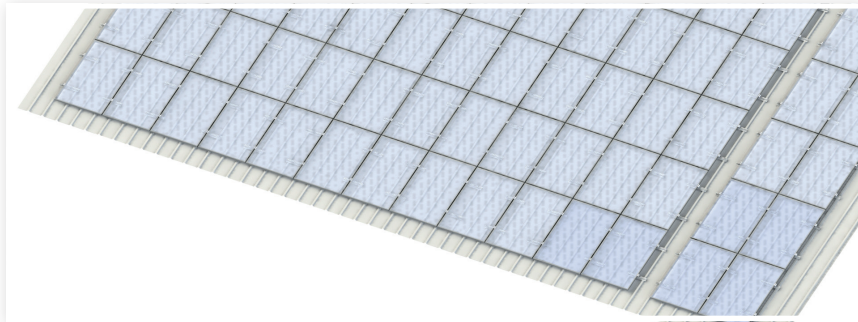

**Detail:** Horizontal thermic separation after 12m.

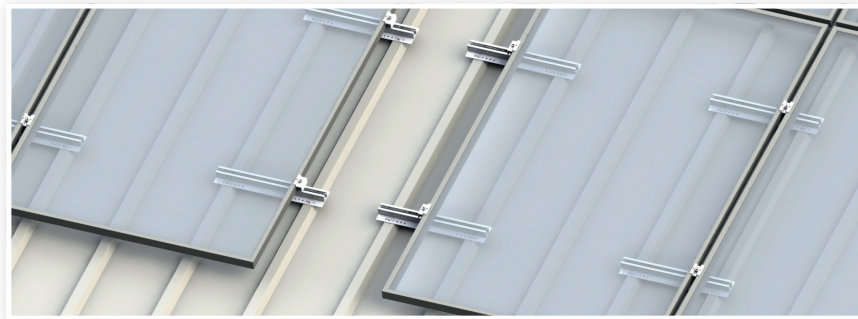

**Option:** If the module clamping area and the sheet profile gap make it possible, for purposes of thermic separation the trapezoidal bridge can be moved to the sheet profile. When mounting large fields of panels, it is important to ensure there are enough maintenance gaps.

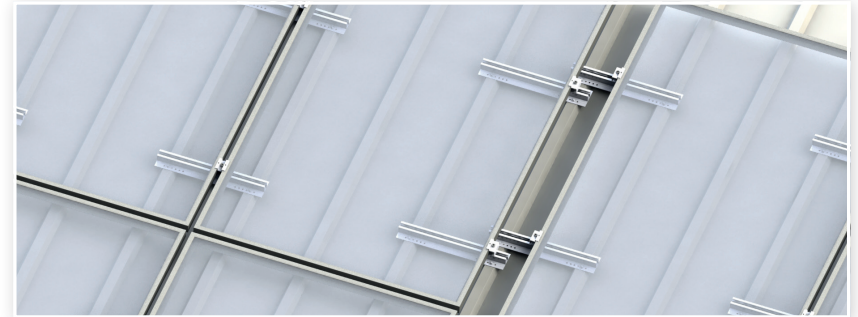

Maintenance gaps should be planned horizontally and vertically for all larger-scale systems.

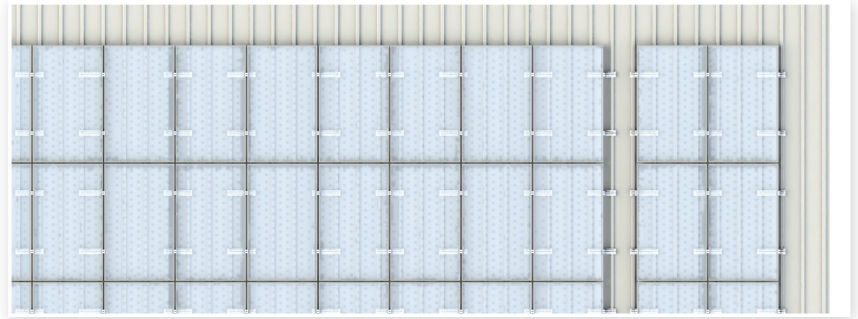



# MOUNTING MODULES

1

## MOUNTING THE END CLAMPS

Begin with the bottom row of the module. Lift the first module onto the trapezoidal bridge and position correctly.

Click in the end clamp by slightly tilting and slide along to the module frame. Tighten to a torque of **15 Nm** with the hex key.

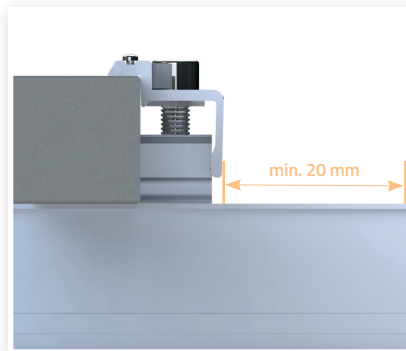
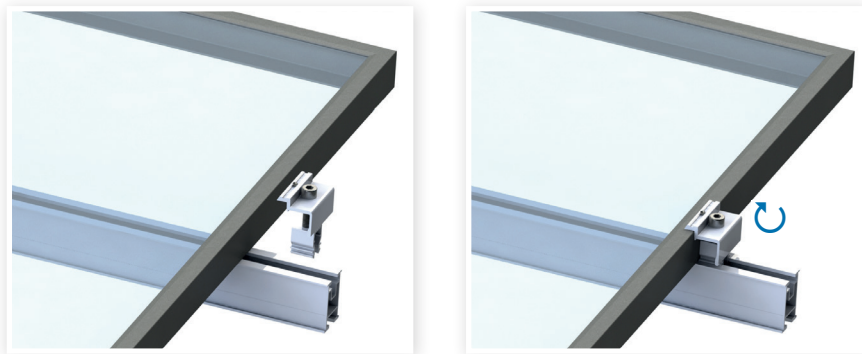

**Please note:** The end clamps must be attached at least 20mm from the end of each mounting profile.



**Please note:** If using end clamps with threaded plates, please ensure the plate is positioned at 90° to the profile channel.

2

## MOUNTING THE MIDDLE CLAMP

Click the middle clamp onto the frame of the previous module at a slight angle. Move the module along until the modules are sitting pressed up to each other! Tighten with a hex key to a torque of **15Nm**.

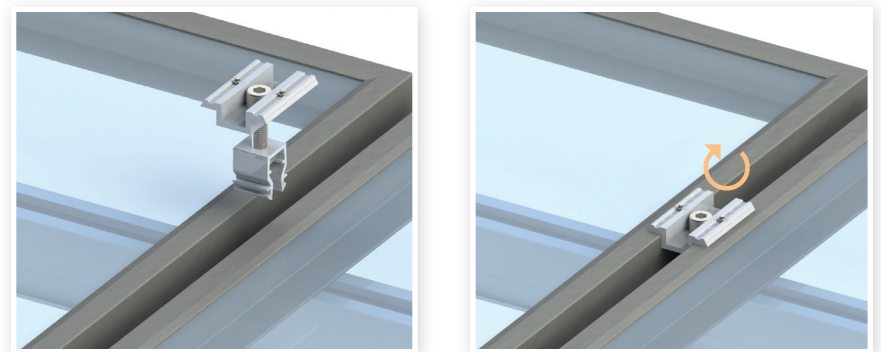

As described, each final module on a module row must be mounted with end clamps. The same applies to the remaining rows of modules.

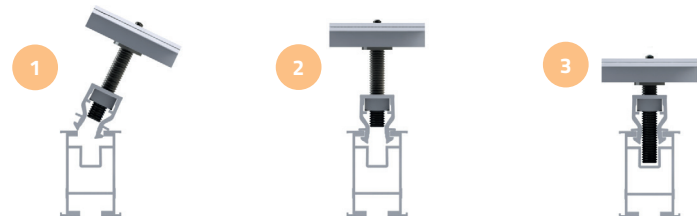

**Please note:**

- Ensure there is a gap of at least **20mm** between the clamp and the end of the trapezoidal bridge!
- Modules must only be clamped in the sections prescribed for attachment! These can be found by consulting the manufacturer's respective module data sheet.
- Horizontal and vertical gaps between the modules must be around **20mm!**

## MOUNTING WITH TRAPEZOIDAL BRIDGES HORIZONTAL MODULE ARRANGEMENT

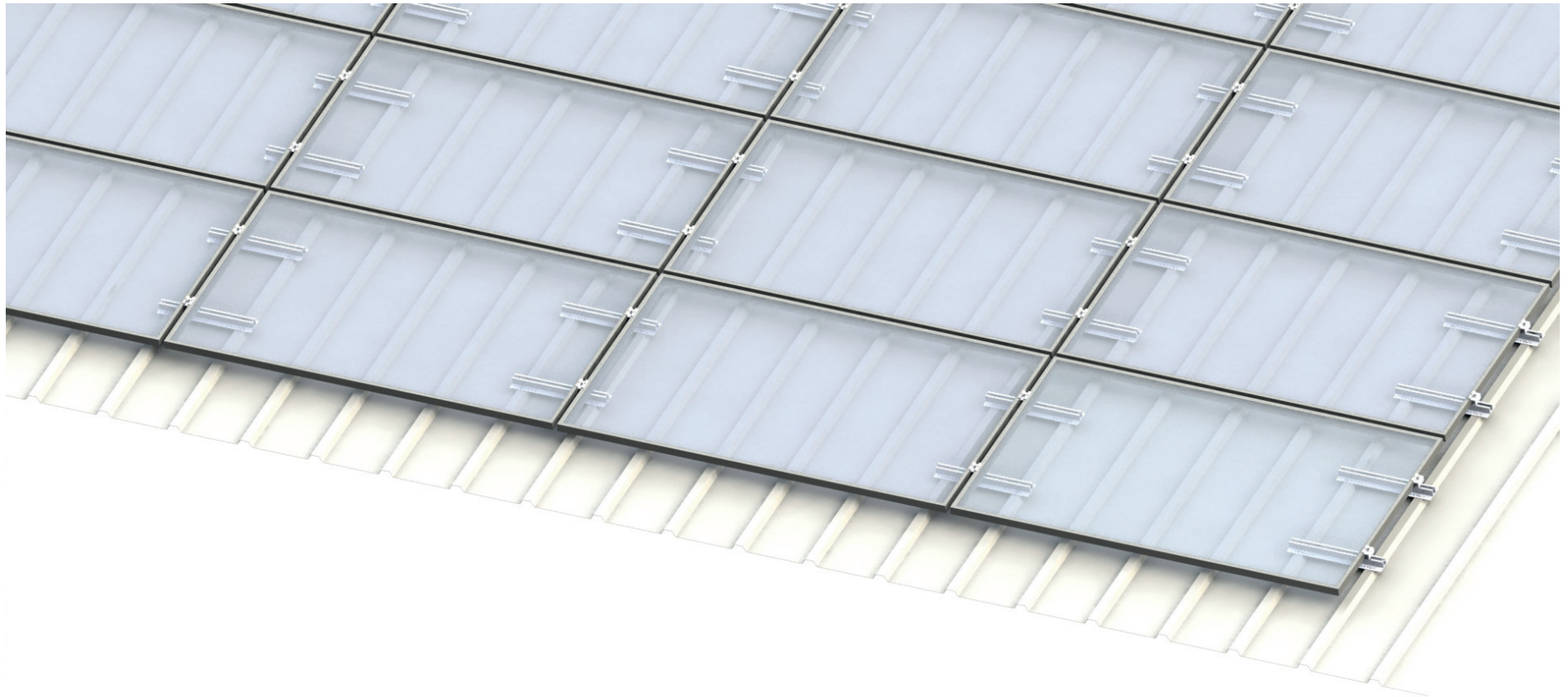

# MOUNTING

1

## MEASURE AND MARK POSITIONS

Measure distances for the trapezoidal bridge and mark positions with a chalk line tool on the roof according to the Solar.Pro.Tool project report. Measure the gap between the sheet metal profiles and position the trapezoidal bridge.

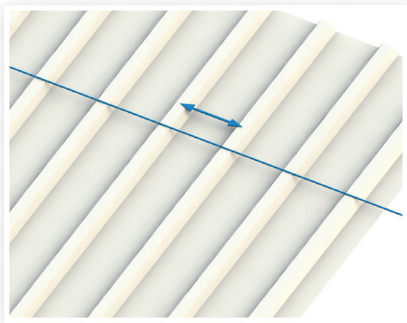

2

## MOUNTING TRAPEZOIDAL BRIDGE

Screw the Trapezoidal Bridge right in the middle of each of two roof sheet profiles with 4 self-drilling screws. Please ensure the EPDM sealing beneath the Trapezoidal Bridge and the sealing discs of the self-drilling screws are not compromised by more than 50%. The gap between the self-drilling screws and the edge of the roof profile must be at least 8mm.

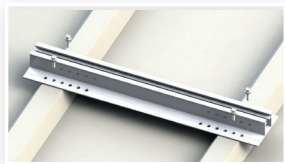

**! Please note:** Once mounted, trapezoidal bridges must not be used as footholds

When placing the subsequent trapezoidal bridges on the next roof profiles, ensure the correct **gap of X** is achieved. The **gap (X)** depends on the width of the module and clamping width (20mm) + the minimum gap to the end of each trapezoidal bridge (20mm).

**Gap Y** depends on the length of the modules and should be chosen to allow clamping in the specified clamping areas.

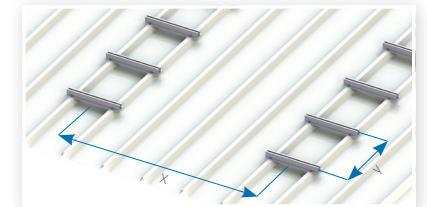
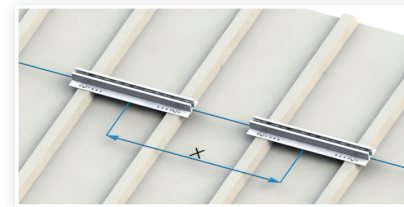

**! Please note:** Adhere to the clamping areas and find out the loads and forces they cause in the installation manual for your specific module.

### Information about screws for thin sheet metal

Turn the self-drilling screws slowly, in a controlled manner and using low torque to ensure you do not over-rotate the screws or damage the sheet metal. Turn the screw until the EPDM sealing under the rail and the self-drilling screws is pressed to around 50% of its original thickness. Continuing to screw no longer strengthens the connection, but instead increases the risk of material failure.

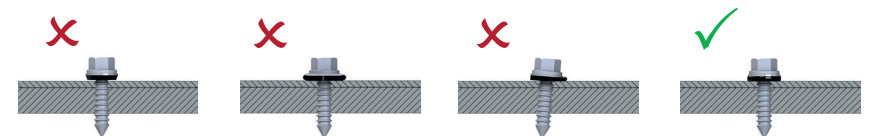

# THERMIC SEPARATION AND MAINTENANCE GAPS

Adhere to the maximum module field length of 12m. There must be a thermic gap between modules once this length is reached. We suggest leaving a gap of one sheet metal profile.

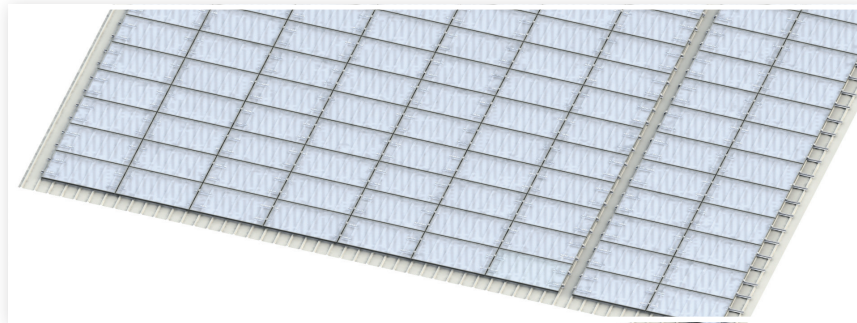

Maintenance gaps should be planned horizontally and vertically for all larger-scale systems.

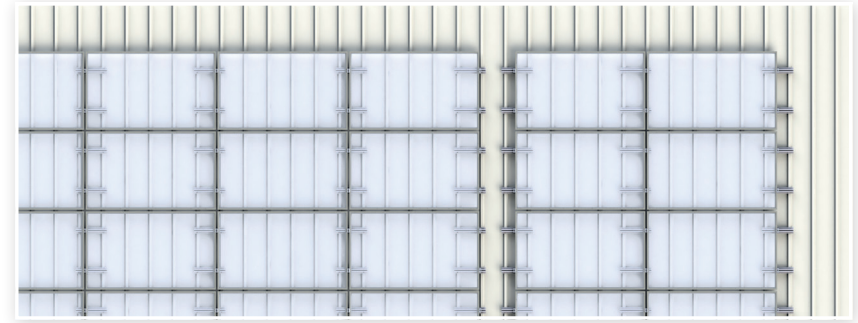

**Detail:** Horizontal thermic separation after 12m.

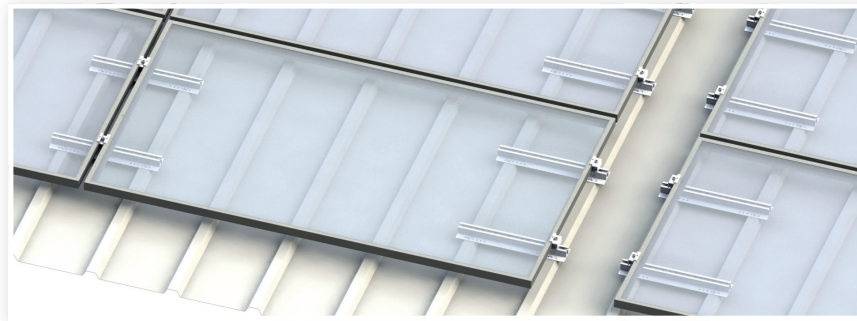

# MOUNTING MODULES

1

## MOUNTING THE END CLAMPS

Begin with the bottom row of the module. Lift the first module onto the trapezoidal bridge and position correctly.

Click in the end clamp by slightly tilting and slide along to the module frame. Tighten to a torque of **15 Nm** with the hex key.

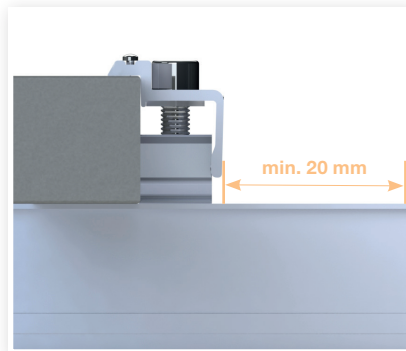
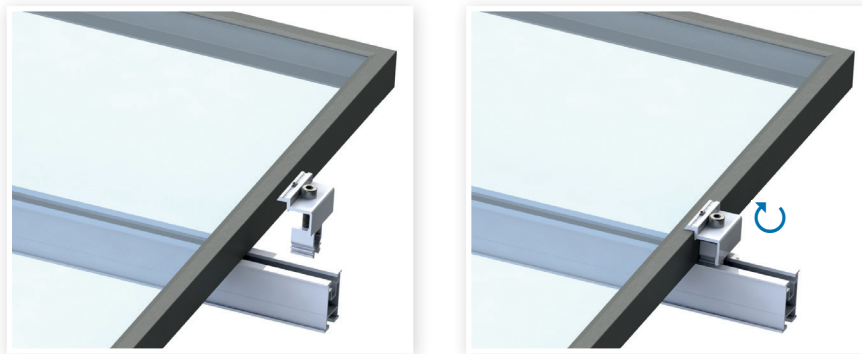

**Please note:** The end clamps must be attached at least 20mm from the end of each mounting profile.



**Please note:** If using end clamps with threaded plates, please ensure the plate is positioned at 90° to the profile channel.

2

## MOUNTING THE MIDDLE CLAMP

Click the middle clamp onto the frame of the previous module at a slight angle. Move the module along until the modules are sitting pressed up to each other! Tighten with a hex key to a torque of **15Nm**.

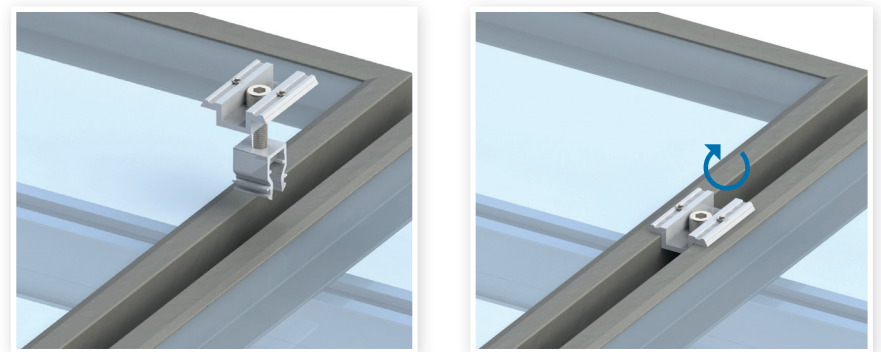

As described, each final module on a module row must be mounted with end clamps. The same applies to the remaining rows of modules.

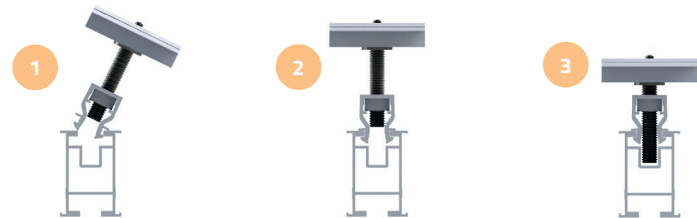

**Please note:**

- Ensure there is a gap of at least **20mm** between the clamp and the end of the trapezoidal bridge
- Modules must only be clamped in the sections prescribed for attachment! These can be found by consulting the manufacturer's respective module data sheet.
- Horizontal and vertical gaps between the modules must be around **20mm!**

## ATTACHING THE MODULE CABLES

1

Module cables must not hang freely or lie unsecured on the roof surface. Press the clip attached to the cable tie into a truss profile channel and bind the cables together with the cable tie.

**Remove the clip from the profile channel by sliding it out sideways.**



## EQUIPOTENTIAL BONDING

Equipotential bonding between the individual parts of the PV roof-mounting system is subject to respective national directives. The following section shows one means of earthing the ALUMERO trapezoidal bridge system. The applicable cable thicknesses and full earthing plans for each country cannot be provided in these instructions. They must be calculated and executed by the certified plumbers and electricians you choose for installation. There are other acceptable means of correctly earthing your infrastructure on top of the ones we have detailed here.

1

### EARTHING ROWS OF TRAPEZOIDAL BRIDGES

Mount a wire clamp to the lower profile channel of every truss profile row. Place the aluminium wire conductor in the wire clamp and secure it by screwing it tight. This ensures every row of modules conducts to every other.



**Attach the aluminium wire with a wire clamp**

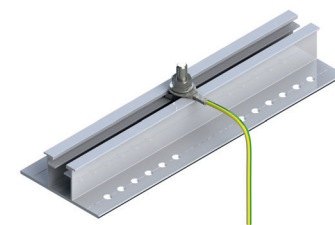

**Attach the earthing wire with an anchor bolt**

## 2

### EARTHING MODULES

The module manufacturer specifies in the respective data sheet as to whether the particular module needs to be earthed. If this is the case, equipotential bonding for your modules can be implemented in the following ways – as recommended by ALUMERO:

ALUMERO end and middle clamps can be used with built-in pin switches to integrate your modules into the equipotential bonding network. These pins are situated in the clamps and puncture the anodised layer of the module frames, thus connecting up all the rows of modules into a circuit.

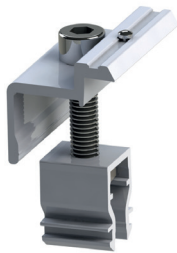

Click end clamp  
with a pin switch

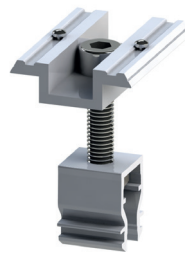

Click middle clamp  
with a pin switch



All graphic representations of products provided in these installation instructions are for demonstration purposes and are not perfectly-scaled images. Subject to changes and errors!

# DONE!

# PLEASE TAKE NOTICE OF THE FOLLOWING INFORMATION!

We recommend you read the following information very carefully as it is of immense importance for handling the product. Please also make sure you are familiar with the safety guidelines and rules for the other components within the system.



# SAFETY INFORMATION AND WARNINGS

The AS 2.1 pitched roof system is intended solely to carry PV modules. Any other applications of the system shall be considered examples of misuse. Correct use of this infrastructure also entails adherence to the guidelines and recommendations in these instructions. ALUMERO shall accept no liability for damages resulting from neglect to adhere to the installation manual, particularly in cases of incorrect use of the product.

- ALUMERO shall under no circumstances accept liability for losses of performance suffered by the system, or damage to the system, whatever their nature.

All work carried out on the PV system should be conducted in full compliance with these instructions. Installation, commissioning, servicing and repair may only be conducted by specialists with recognised relevant certification and qualifications.

Please observe all current and applicable rules and safety advice.

### Observation of these accident prevention regulations is mandatory:



- BGV A 1 – General official guidelines
- BGV A 3 – Electric systems and items in operation
- BGV C 22 – Construction and installation work (PPE for fall prevention & falls)
- BGV D 36 – Ladders and steps
- Trade association rules on health and safety at work BGR 203 for work on roofs, and DIN EN 516 regarding infrastructure required to work on roofs, work clothing and work safety rules according to trade association regulations



### You are obliged to adhere to the following DIN norms:



- DIN 18299 – General regulations for all types of construction work
- DIN 18338 – Roof covering and roof sealing work
- DIN 18360 – Metal structure work and construction
- DIN 4102 – Combustibility and flammability of building materials and components

Work on systems made by Alumero Systematic Solutions GmbH may only be conducted by authorised personnel. The system operator is obliged to observe the following safety conditions:



- We require that the AS 2.1 pitched roof system components and the outer surface of the roof installed are inspected and serviced at least once a year. At a minimum, the following points must be checked:
  - » All mechanical connections must be checked to ensure they are stable, secure and correctly tightened
  - » The situation of the system on the roof, and the condition of the system itself as regards deformation
  - » Cabling must be inspected to ensure there is no damage
  - » PV modules must be inspected to ensure there is no damage

- The frames may only be mounted by personnel with relevant qualifications, trade skills and basic knowledge of the mechanics involved.



- Make sure personnel charged with mounting, installation and servicing on your behalf are capable of evaluating the hazards and recognising the possible dangers.

- This installation manual is integral to the product itself and must be available at all times during mounting and installation.



- Ensure all personnel charged with mounting and installing systems have read and understood the installation instructions, and particularly the safety information, before work commences.

- There must be absolute compliance with the rules and regulations of the responsible trade association, local work safety directives and all applicable rules for technical equipment.



- Only suitable lifting devices and ladders must be used for mounting purposes. The use of ladders that are only leaned against structures is not permitted

- Evaluation of the existing structural statics of the building and roof in question must be conducted by a certified structural engineer to ensure existing structures can bear the additional weight and forces caused by a PV system.

- Make sure you are aware that ALUMERO Systematic Solutions GmbH applies maximum weight limits to take various eventualities into account, such as the need to climb on roofs to clear snow and reduce weight.

## PRODUCT GUARANTEE / EXCLUSION OF LIABILITY

Information about dimensioning in these instructions is provided from past experience. Binding installation statics for frames and structures can be generated using ALUMERO Solar.Pro.Tool.

The company mounting and installing the system is responsible for ensuring all such work is executed correctly. ALUMERO Systematic Solutions GmbH accepts no liability for the reliability of dimensioning information provided in system sales offers.



The company mounting and installing the system is responsible for the mechanical sustainability of connections mounted on, and to the outside of, the building, particularly in terms of watertightness. ALUMERO Systematic Solutions GmbH's components are designed to correspond with the latest technical standards and to cope with the loads and forces to which such systems are commonly exposed. On submitting an inquiry/order you are required to use the project questionnaire to inform ALUMERO Systematic Solutions GmbH in writing/print about all the general technical conditions prevailing on-site, such as support structure details, snow load zone, building heights, wind loads etc.

ALUMERO Systematic Solutions GmbH accepts no liability for the incorrect handling of parts built into the system.

In order to avoid corrosion, the aluminium construction may only come into contact with media (solid, liquid, gaseous) that have a PH value from 4,5 till 8,5.

If used correctly, dimensioned within statutory static tolerance levels calculated for the site, and operated under normal local weather and environmental conditions, ALUMERO Systematic Solutions GmbH grants a 2-year product guarantee for the working life and durability of the support frame systems. It is valid for generally prevalent meteorological and environmental conditions.

Materials and finishing guarantee: ALUMERO Systematic Solutions GmbH provides a 10-year guarantee on all materials and finishing. For more information, please see the specific guarantee conditions.

## INFORMATION ABOUT ELECTRICAL INSTALLATION



All work with electricity, or on devices carrying electrical currents, must be conducted by trained electricians. Compliance must be guaranteed with all the applicable DIN norms, VDE rules, VDEW guidelines, VDN directives, accident prevention rules and the directives of the local energy suppliers.

- DIN VDE 0100: Installation of high-voltage systems with nominal voltages of up to 1000 V)
- VDEW directive: For the parallel operation of self-generation systems with the EVU low voltage mains system
- VDI 6012 directive for decentralised energy systems in buildings: Photovoltaics
- Info sheet for the VDEW directive: 'Low-Voltage Mains Self-Generation Systems'
- VDN directives on 'Low-voltage mains'
- DIN/VDE directives, DIN/VDE 0100 'The Installation of High-Voltage Systems Using Mains Voltages of up to 1000 V', particularly VDE 0100 part 410: 'Prevention of Direct or Indirect Contact' (DC voltage > 120 V, < 1000 V) and 'Trade Association Accident Prevention and Protection' VBG4 'Electrical Systems and Components'
- DIN VDE 0100-540: Selection and installation of earthing, conductors and equipotential bonding conductors
- VDE 0185 on the establishment of a lightning conduction system and VDS 2010

## KEY WARNINGS



Solar modules generate electricity as soon as they are exposed to sunlight. Hence, they are constantly electrically 'live'. Fully-insulated plug and socket contacts provide protection in case of physical contact. However, the following rules must be observed in contact with solar modules:

- Do not place any electrically conductive items in the plugs or sockets.
- Do not install solar modules or power cables if plugs or sockets are wet.
- Be extremely careful when carrying out any work on power cables.
- Do not conduct any electrical installation work where there is moisture.



Even when there is only a small amount of light available, serially-connected solar modules may still use very high direct current voltages, and contact with these can be lethal. Please be aware of the secondary injuries and damage caused by electric shocks.

Even when switched off inverters can still pass on powerful electrical charges on contact:

- Take special care when working with the inverter and power conduits.
- Before further work is conducted, it is essential to adhere to offline intervals recommended by the manufacturer once the inverter has been switched off to ensure the power in high-voltage components has time to discharge.
- Please adhere to all installation specifications provided by the manufacturer of the inverter.



Lethal arc flashes may be generated when disconnecting a power conduit, such as when disconnecting an inverter from the DC power supply while still bearing a current:

- Never disconnect the solar generator from the inverter while still connected to the mains.

## NORMS AND GUIDELINES

All norms and guidelines presented here are published and intended for use in Germany. The guidelines provided in each respective edition must be complied with. Please note that installations outside Germany will also be subject to additional national norms and guidelines.

## HOW TO INSTALL THE FRAMEWORK

All roof area installations must be carried out in accordance with currently valid technical building standards, particularly those specified in the DIN norms and the requirements formulated in the 'German Roofers' Rulebook'.



- Check to ensure all screwed attachments are correctly tightened.
- Adhere to the suggested torque values.
- Regardless of the testability of the statics, prior to every installation it is essential to ensure the product complies with DIN EN 1991 statics requirements on site.
- DIN Norm EN 1991 'Forces Affecting Load-Bearing Structures' – and all accompanying national application documents.
  - Part 1-1: Weight, weight distribution, counterweighting and payloads in above-ground construction
  - Part 1-3: Snow loads
  - Part 1-4: Wind loads
- DIN Norm EN 1990: 'The Fundamentals of Support Structure Planning' – and all accompanying national application documents.
- The structure on which the system is mounted is evaluated for compliance under DIN EN 1993 'Measurement and Construction of Steel Structures', and DIN EN 1999 'Measurement and Construction of Aluminium Support Structures'.
- Ensure suitability of the substructure for load-bearing purposes, like dimensions, current conditions, relevant material properties, general load-bearing structures – and of all individual layers affected such as layers of insulation.
- Ensure the flow and drainage of rainwater is not obstructed.
- Always take the physical effects on building work into account, such as the risk of dew penetrating layers of insulation.



## PRODUCT LIABILITY

The technical documentation is an integral part of the product. Alumero Systematic Solutions GmbH shall bear no liability for damages that occur due to non-adherence to the installation instructions, particularly to safety information, or due to misuse of the products.

YOUR DEALERSHIP



# CONGRATULATIONS & WELL DONE!

## CONTACT HEADQUARTERS

ALUMERO Systematic Solutions GmbH  
Sonnenweg 1-2  
5162 Seeham - Österreich

T +436217 / 68 41 - 0  
F +436217 / 68 41 - 41  
solar@alumero.at  
www.alumero.at